



# ELEVATOR SOLUTIONS



**KINETEK®**  
*Technology in Motion*

## Contents

Kinetek Elevator Packages	2–9
Cabs and Entrances	10–11
Finishes	12
Floor Treatments	13
Lighting	14
Car and Hall Fixtures	15
Machines and Safety Components	16-17
Controllers	18-19
Monitoring and Dispatching	20–21
Escalators and Moving Walkways	24–25





Kinetek provides complete elevator packages for machine room and machine room-less applications. These open architecture solutions provide customers with the most innovative, highest performing and most cost effective products in the industry.

## The Kinetek Advantage

Driven by a market need for custom-tailored elevator packages, Kinetek's Elevator & Escalator Solutions Group (EESG) provides flexible elevator designs that will fit into a wide range of hoistways — whether machine room-less or overhead traction. Kinetek provides the optimal solution for any new construction or modernization project.

From controls and machines to cabs and fixtures, Kinetek provides you with many design options. Drawing on the unique capabilities of our U.S. and Chinese design centers, we take full advantage of precise engineering coupled to efficient manufacturing expertise. Proven engineering strength, global sourcing, and field-tested quality, along with our willingness to accept challenging requirements, set us apart from the competition.

Over the past decade, Kinetek laid the groundwork for today's product offerings by combining the global leadership of our diverse operating companies, including Motion Control Engineering (MCE), Imperial Electric, Kinetek

De Sheng (KDS), and Zhongxiu Kinetek (ZXK) into one innovative and comprehensive team — Kinetek's Elevator & Escalator Solutions Group.

Kinetek takes pride in being the leading open architecture provider in the elevator industry. Equipment, installation, and service choices are made by building owners and their representatives. Together, we can provide cost-effective, high quality solutions that will return satisfaction and the knowledge of a job well done over years of service.

Kinetek's Elevator & Escalator Solutions Group is part of Kinetek, a privately-held global manufacturing company with 28 facilities in North America, Europe and Asia. Kinetek companies hold market leading positions in elevator/escalator, commercial floor care, material handling/aerial lift, golf/utility vehicle, medical, renewable energy and commercial food equipment markets.

# Kinetek Elevator Packages

Kinetek MRL and overhead traction elevator packages are designed to provide independent and OEM elevator contractors with reliable, turn-key, custom solutions for any modernization or new construction project.

At the core of our packages are the most sophisticated open architecture controllers, machines and peripherals in the industry. Couple these with the highest quality cabs and entrances, surfaces and fixtures available, and Kinetek Elevator Packages will meet the expectations of the most demanding customers.

## Kinetek Elevator Packages

With design centers on two continents, we have the advantage of understanding the elevator marketplace across a very broad perspective. Our elevator packages reflect this flexibility:

**Standard and Cantilevered MRLs** — 350 to 1600 kg loads at speeds to 2.0 meters per second. Conventional and cantilever designs available. (Pages 3 and 4)

**Expanded Capacity MRLs**— Loads up to 2000 kg (2:1 roping) or 2100 to 3500 kg (4:1 roping). Conventional design. (Page 5)

**Standard Machine Room** — Speeds up to 6.0 meters per second. Conventional, overhead machine room installations. (Page 8)

**Vehicle Lifts** — Hydraulic or traction, speeds to 0.75 m/s. (Page 9)

**Hydraulics** — Hydraulic installations. Traditional or roped.

## Standard Features

**Controls** — iControl, ZXK 3200, ZXK 3000, Motion 4000 and Motion 4000MRL.

**Machines** — Kinetek permanent magnet AC gearless for MRL or overhead machine room installations.

**Safety components** — Governor and tension sheave/weight, safeties, safety switches.

**Door operators** — From Kinetek or selected manufacturers.

**Cabs, doors and entrances** — Precision steel construction.

**Surfaces** — Traditional horizontal, vertical, or mixed panel interiors or your choice of car interior providers.

**Fixtures** — Quality Kinetek car and hall fixtures, or customer specified.

**Rail components** — Rails, fishplates, brackets, clips and hardware as required, sized for application.

**Rope** — Industry standard, traction steel wire rope.

**Counterweight components** — Complete with frame, fillers, roller guides, rails. All required hardware.

**Traveler/hoistway cables** — Pre-cut to required lengths. Hangers and hardware as required.

**Hardware** — All nuts, bolts, washers and brackets per complete package installation.

**Kinetek Support** — One source for complete package support.



## HOISTWAY PLAN

## HOISTWAY SECTION

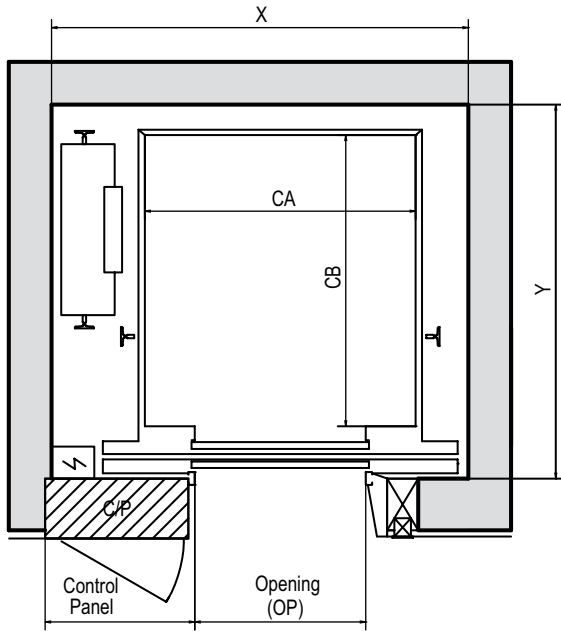

**Top Floor (with control panel)  
CENTER OPENING**

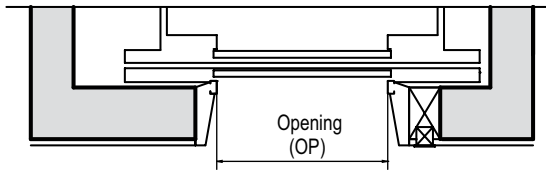

**OTHER FLOORS**

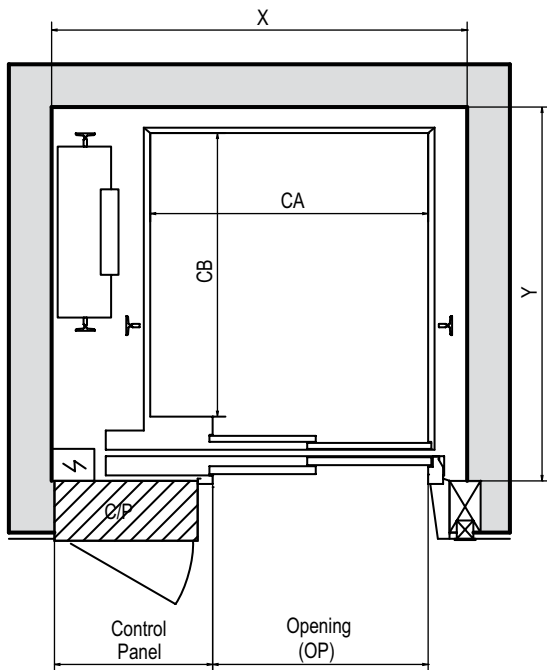

**Top Floor (with control panel)  
SIDE OPENING**

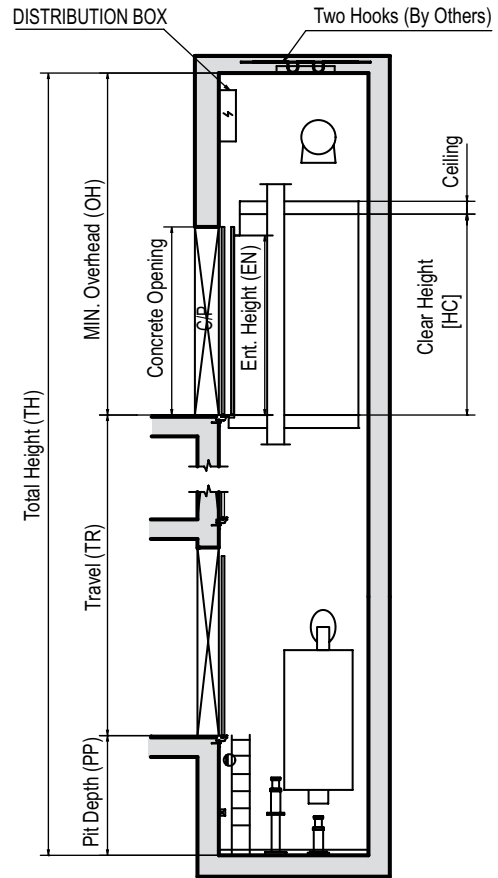

**CENTER OPENING STANDARD DIMENSIONS (units: mm)**

Capacity		Speed m/s	Max Clear Opening	Car Inside CA x CB	Hoistway X x Y
KG	Persons				
550	7	0.5/1.0/1.5	800 (CO)	1150x1300	1750x1650
630	8	0.5/1.0/1.5	800 (CO)	1150x1400	1750x1750
800	10	0.5/1.0/1.5/1.75	900 (CO)	1400x1450	2000x1800
1000	13	0.5/1.0/1.5/1.75	900 (CO)	1550x1500	2150x1850

**SIDE OPENING STANDARD DIMENSIONS (units: mm)**

Capacity		Speed m/s	Max Clear Opening	Car Inside CA x CB	Hoistway X x Y
KG	Persons				
320	4	0.5/1.0/1.5	800 (SO)	900x1025	1500x1500
400	5	0.5/1.0/1.5	800 (SO)	1000x1100	1600x1500
450	6	0.5/1.0/1.5	800 (SO)	1100x1150	1650x1550
550	7	0.5/1.0/1.5	800 (SO)	1100x1360	1650x1750
630	8	0.5/1.0/1.5	900 (SO)	1100x1400	1650x1800
800	10	0.5/1.0/1.5/1.75	900 (SO)	1400x1500	2000x1950
1000	13	0.5/1.0/1.5/1.75	1000 (SO)	1100x2100	1650x2500

Speed m/s	Min. Overhead OH (mm)	Min. Pit PP (mm)	Max Travel (m)
0.5	3600	1155	25
1.0	3600	1155	45
1.5	3850	1550	65
1.75	3900	1600	75

Note: 1). HC=2200; 2). For P13 capacity, if decoration weight greater than 200 kg, increase pit depth 100mm.

## HOISTWAY PLAN

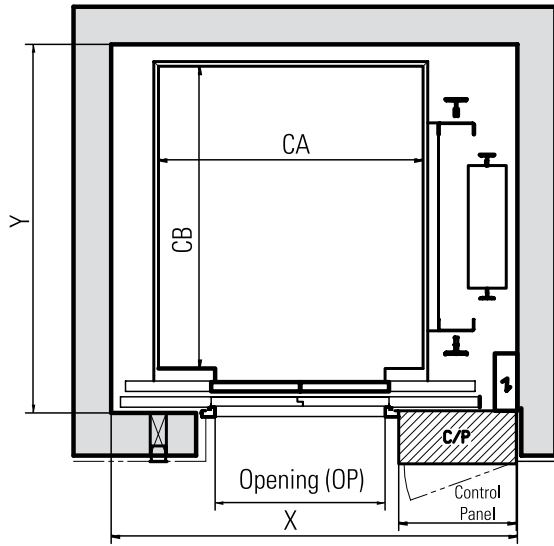

Top Floor (with control panel)

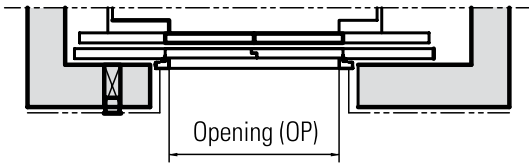

OTHER FLOORS

## HOISTWAY SECTION

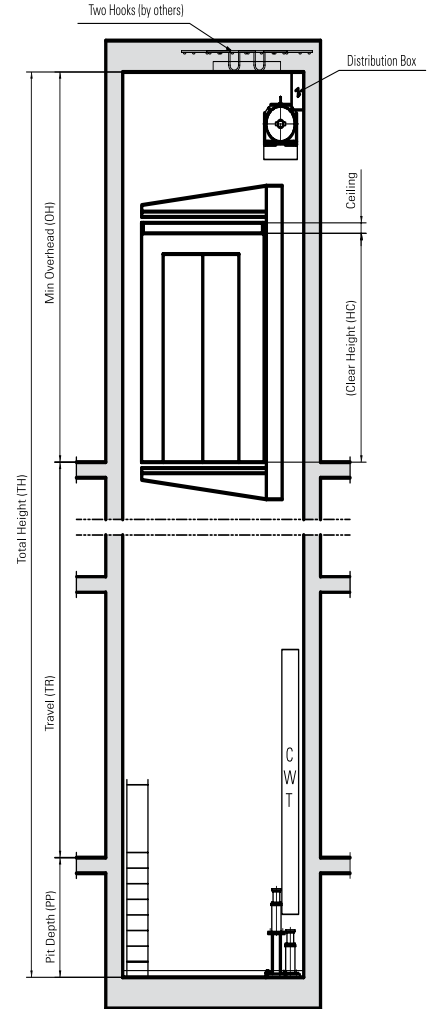

### CENTER OPENING STANDARD DIMENSIONS (units: mm)

Capacity (1:1)		Speed m/s	Max Clear Opening	Car Inside	Hoistway
KG	Persons			CA x CB	X x Y
630	8	0.5/1.0	800 (SO)	1100x1400	1750x1765
800	10	0.5/1.0	900 (SO)	1400x1490	2500x1865
1000	13	0.5/1.0	900 (CO)	1500x1490	2150x1800

### SIDE OPENING STANDARD DIMENSIONS (units: mm)

Capacity (2:1)		Speed m/s	Max Clear Opening	Car Inside	Hoistway
KG	Persons			CA x CB	X x Y
1150	15	0.5/1.0	1000 (CO/SO)	According to Customer's requirements	
1350	18	0.5/1.0	1000 (CO/SO)		

Speed (1:1) m/s	Min. Overhead OH (mm)	Min. Pit PP (mm)	Max Travel (m)
0.5	3700	1100	25
1.0	3700	1100	45

Speed (2:1) m/s	Min. Overhead OH (mm)	Min. Pit PP (mm)	Max Travel (m)
0.5	3850	1250	25
1.0	3850	1250	45

Note: HC = 2200 mm (Clear Height)

## HOISTWAY PLAN

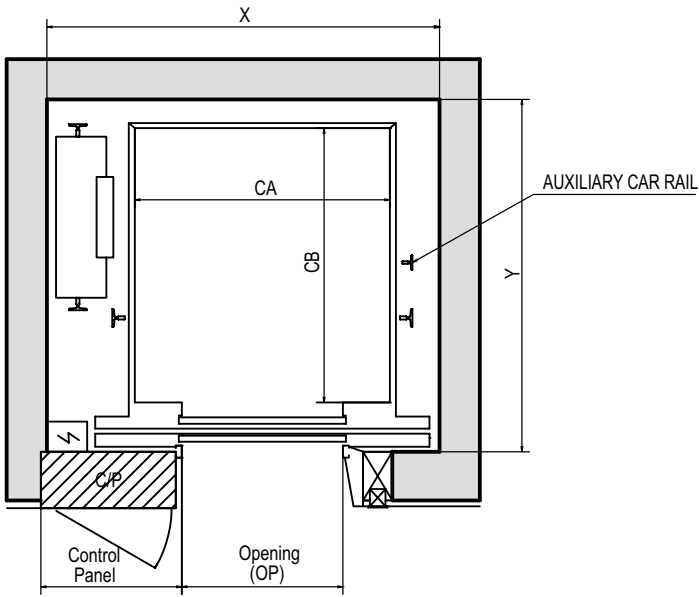

**Top Floor (with control panel)  
CENTER OPENING**

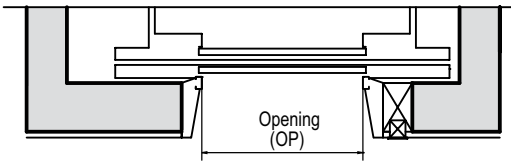

**OTHER FLOORS**

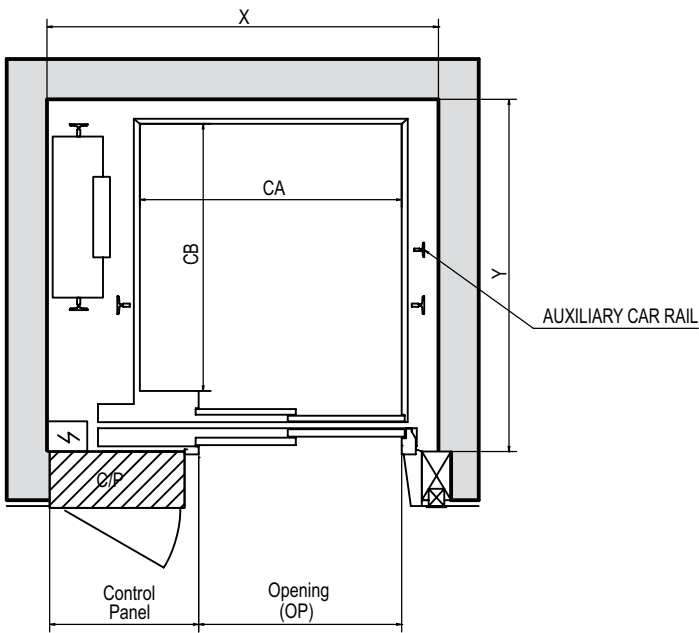

**Top Floor (with control panel)  
SIDE OPENING**

## HOISTWAY SECTION

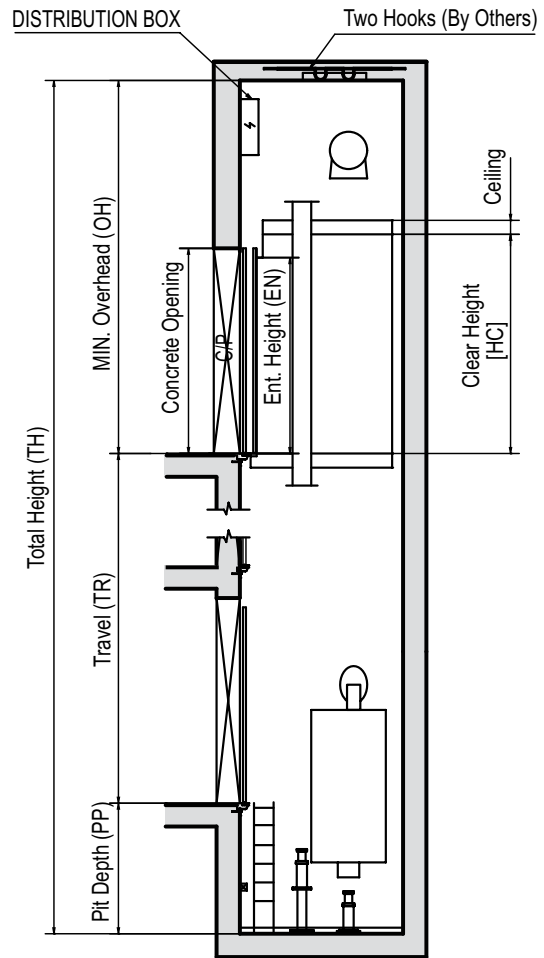

### CENTER OPENING STANDARD DIMENSIONS (units: mm)

Capacity		Speed m/s	Max Clear Opening	Car Inside CA x CB	Hoistway X x Y
KG	Persons				
1150	15	0.5/1.0/1.5/1.75	1000 (CO)	1650x1650	2500x2050
1350	18	0.5/1.0/1.5/1.75	1000 (CO)	1700x1810	2600x2400
1600	21	0.5/1.0/1.5/1.75	1100 (CO)	1800x1950	2700x2500
1800	24	0.5/1.0/1.5/1.75	1100 (CO)	1800x2100	2700x2500
2000	26	0.5/1.0/1.5/1.75	1200 (CO)	2000x2100	2900x2500

### SIDE OPENING STANDARD DIMENSIONS (units: mm)

Capacity		Speed m/s	Max Clear Opening	Car Inside CA x CB	Hoistway X x Y
KG	Persons				
1350	18	0.5/1.0/1.5/1.75	1200 (SO)	1800x2350	2200x2850
1600	21	0.5/1.0/1.5/1.75	1200 (SO)	1500x2350	2400x2850
1800	24	0.5/1.0/1.5/1.75	1300 (SO)	1600x2350	2500x2850
2000	26	0.5/1.0/1.5/1.75	1400 (SO)	1750x2350	2650x2850

Speed m/s	Min. Overhead OH (mm)	Min. Pit PP (mm)	Max Travel (m)
0.5	3800	1400	25
1.0	3900	1400	45
1.5	4000	1550	65
1.75	4050	1600	75

Note: HC = 2350

**HOISTWAY PLAN  
TYPE I**

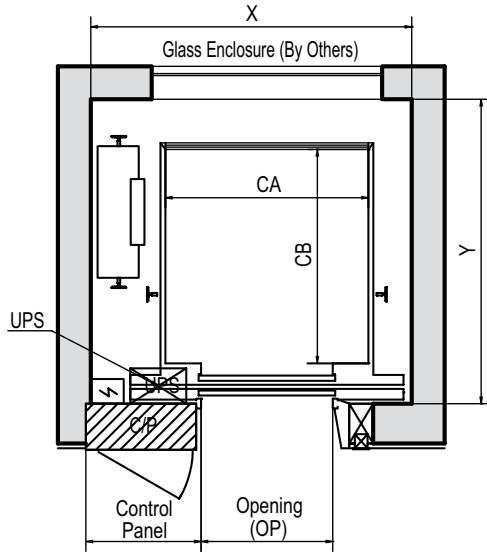

**HOISTWAY PLAN  
TYPE II**

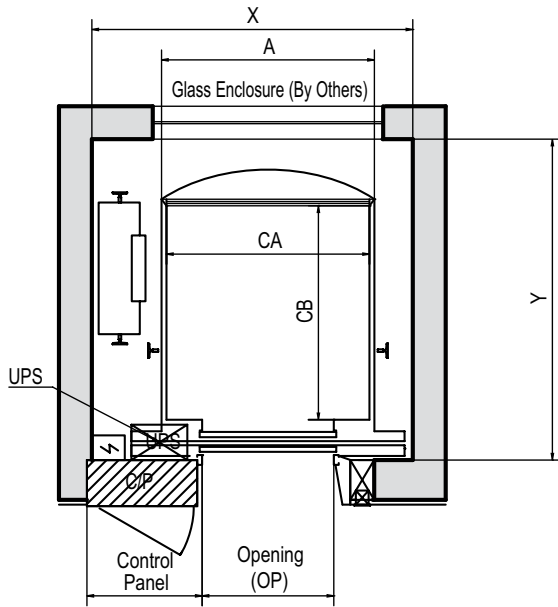

**Top Floor (with control panel)**

**HOISTWAY SECTION**

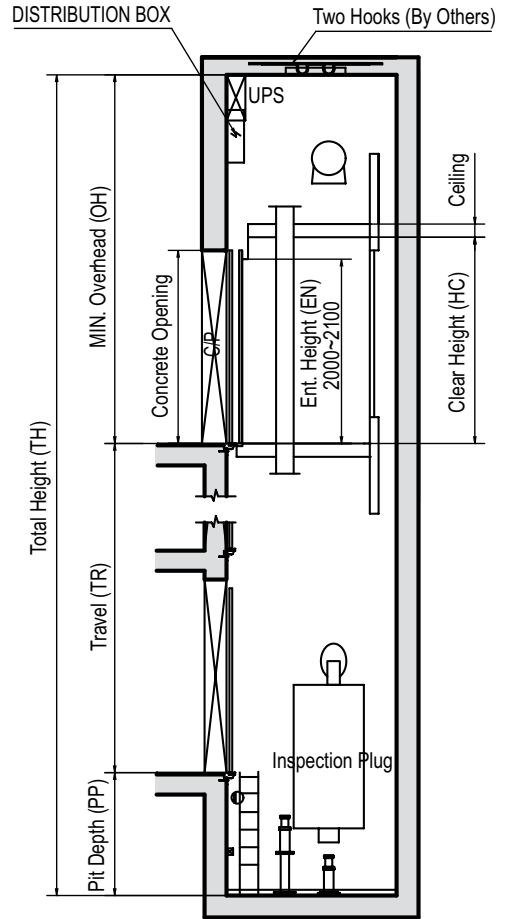

**CENTER OPENING STANDARD DIMENSIONS (units: mm)**

Cage	Capacity		Speed m/s	Max Clear Opening	Car Inside CA x CB	Hoistway X x Y
	KG	Persons				
I	630	8	0.5/1.0	700 (CO) 800 (CO)	1100x1400	1850x1950 1950x1950
	800	11	0.5/1.0/1.5/1.75	800 (CO)	1300x1470	2050x2000
	1000	13	0.5/1.0/1.5/1.75	900 (CO)	1400x1550	2250x2100
II	630	8	0.5/1.0	700 (CO) 800 (CO)	1100x1400	1850x1950 1950x1950
	800	11	0.5/1.0/1.5/1.75	800 (CO)	1300x1470	2050x2200
	1000	13	0.5/1.0/1.5/1.75	900 (CO)	1400x1550	2250x2100

Speed m/s	Min. Overhead OH (mm)	Min. Pit PP (mm)	Max Travel (m)
0.5	4200	1800	25
1.0	4200	1800	45
1.5	4300	1900	65
1.75	4350	2000	75

Note: HC = 2350



**HOISTWAY PLAN  
TYPE III**

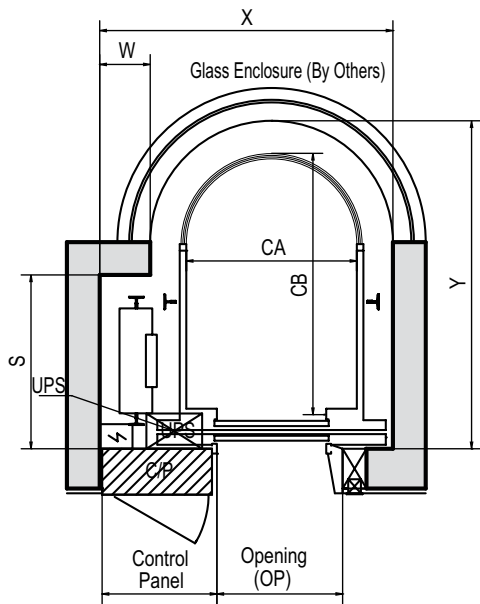

**HOISTWAY PLAN  
TYPE IV**

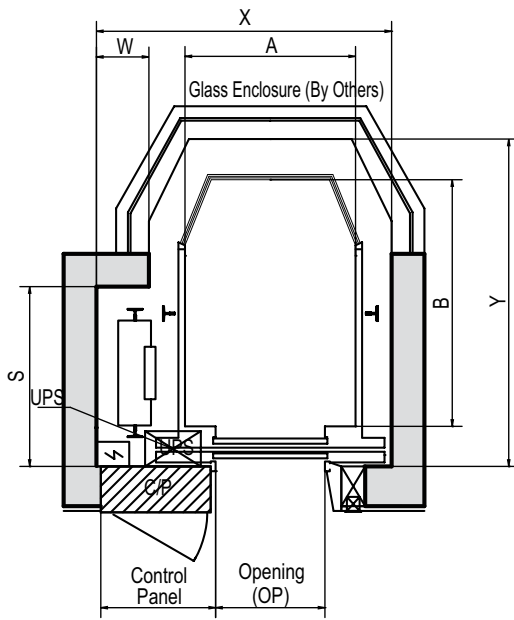

**Top Floor (with control panel)**

**HOISTWAY SECTION**

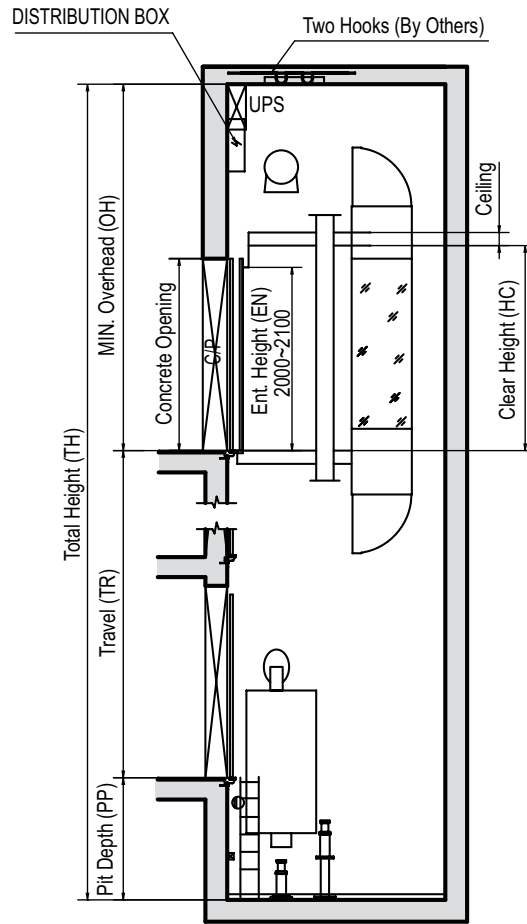

**CENTER OPENING STANDARD DIMENSIONS (units: mm)**

Cage	Capacity		Speed m/s	Clear Opening	Car Inside CA x CB	Hoistway		
	KG	Persons				X x Y	S	W
III	800	11	0.5/1.0/1.5/1.75	800 (CO)	1300x1710	2200x2250	1250	440
				800 (CO)	1300x1950	2240x2500	1325	390
	1000	13	0.5/1.0/1.5/1.75	850 (CO)	1350x1900	2300x2450	1250	390
IV	800	11	0.5/1.0/1.5/1.75	800 (CO)	1300x1600	2200x2150	1200	440
				800 (CO)	1300x1880	2240x2450	1325	390
	1000	13	0.5/1.0/1.5/1.75	850 (CO)	1350x1830	2300x2400	1250	390
				850 (CO)	1350x1830	2300x2400	1250	390

Capacity (kg)	Speed m/s	Min. Overhead OH (mm)	Min. Pit PP (mm)	Max Travel (m)
800	0.5	4600	2000	25
	1.0	4600	2000	45
	1.5	4700	2100	65
	1.75	4750	2200	75
1000	0.5	4200	2000	25
	1.0	4200	2000	45
	1.5	4300	2100	65
	1.75	4350	2200	75

Note: HC = 2350

**HOISTWAY PLAN**

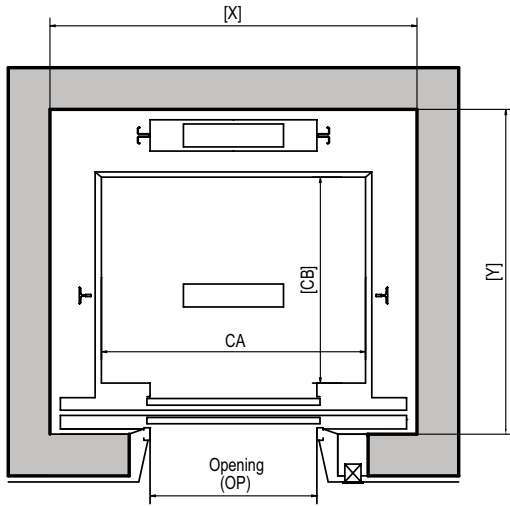

**PIT PLAN**

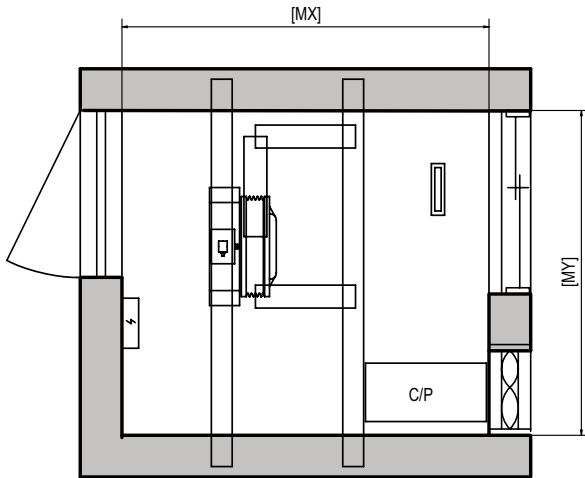

**OVERHEAD PLAN**

**HOISTWAY SECTION**

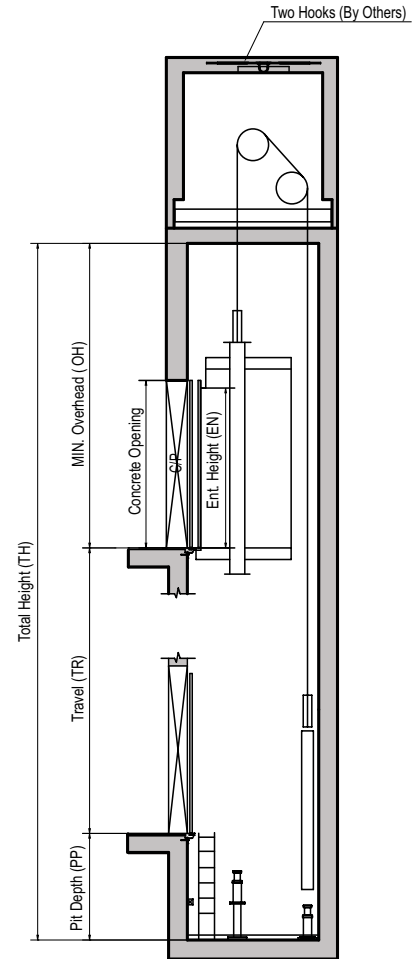

**STANDARD DIMENSIONS (Center Opening)**

Capacity		Speed m/s	Max Clear Opening	Car Inside CA x CB	Hoistway X x Y
KG	Persons				
630	8	1.0/1.5/1.75	800	1400x1100	1800x1750
800	10	1.0/1.5/1.75	800	1400x1350	1800x2000
900	12	1.0/1.5/1.75	900	1600x1350	2050x2000
1000	13	1.0/1.5/1.75	900	1600x1500	2050x2150
1150	15	1.0/1.5/1.75	1000	1800x1500	2350x2280
1350	18	1.0/1.5/1.75	1000	1800x1700	2350x2480
1600	21	1.0/1.5/1.75	1000	2000x1750	2550x2530
800	10	2.0/2.5	800	1400x1350	2000x2185
900	12	2.0/2.5	900	1600x1350	2300x2200
1000	13	2.0/2.5	900	1600x1500	2300x2350
1150	15	2.0/2.5	1000	1800x1500	2300x2350
1350	18	2.0/2.5	1000	1800x1700	2500x2550
1600	21	2.0/2.5	1000	2000x1750	2700x2600

Speed m/s	Min. Overhead OH (mm)	Min. Pit PP (mm)	MR Height MH (mm)
1.0	4300	1400	2200
1.5	4500	1600	2200
1.75	4600	1700	2200
2.0	4800	2100	2200
2.5	5000	2400	2200

## TRACTION VEHICLE LIFT Machine Room-Less

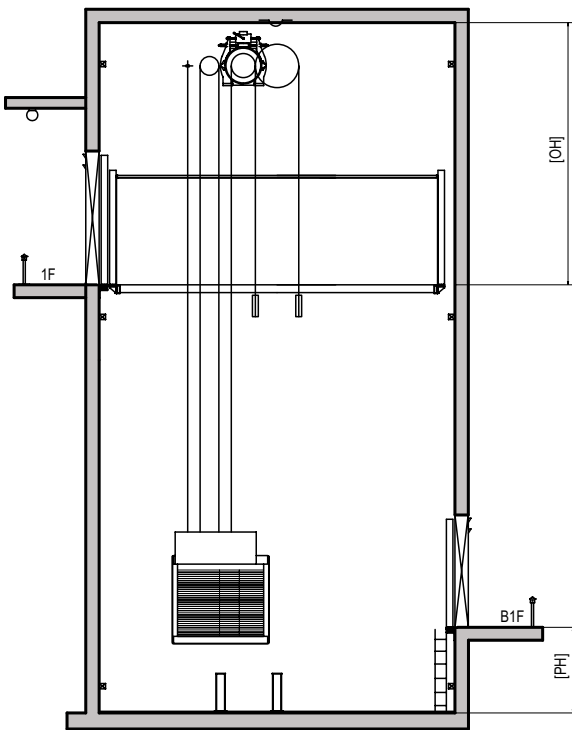
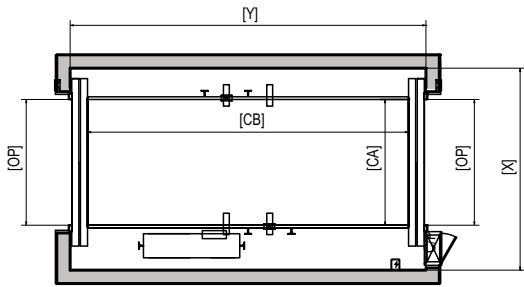

Machine room-less traction vehicle lift shown. Also available for hydraulic and machine room traction vehicle lift applications.

### 1. Indicator lamp (green)

Lights to signal OK to enter when the car is empty and the doors are fully open.

### 2. "IN USE" lamp (Red)

Lights if a call is registered when the elevator is in use.

### 3. Hall position indicator

Hall call and door close buttons, and position indication.

### Signal Provisions

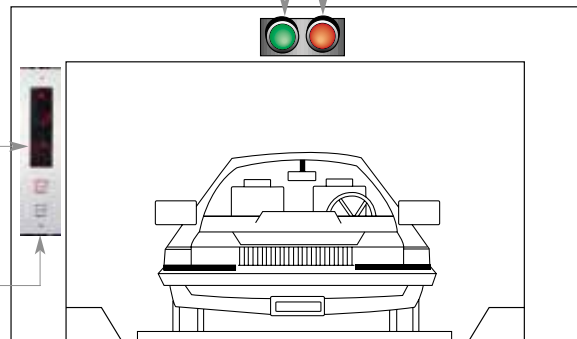

### 4) Stop indicator lamp (Red)

Lights when door is opening or closing. Lights when an entering car is correctly positioned in the lift. Lights when the elevator is running.

## SPECIFICATIONS

### CENTER OPENING STANDARD AREA DIMENSIONS (units: mm)

Type	Specification	Clear Opening	Car Interior	Hoistway	Machine Room
		OP	CA x CB	X x Y	MX x MY
Hydraulic	A2500-C030/45	2350	2350x5310	3450x5960	2500x2800
	A3000-C030/45	2400	2400x6250	3550x6900	2500x2800
	A3500-C030/45	2750	2750x6350	3950x7000	2500x2800
Traction Machine Room	A2500-C030/45	2350	2350x5310	3775x5960	3775x5960
	A3000-C030/45	2400	2400x6250	3825x6900	3825x6900
	A3500-C030/45	2750	2750x6350	4200x7000	4200x7000
Traction Machine Room-Less	A2500-C030/45	2350	2350x5310	3775x5960	
	A3000-C030/45	2400	2400x6250	3825x6900	
	A3500-C030/45	2750	2750x6350	4200x7000	

### PERFORMANCE AND VERTICAL DIMENSIONS (units: mm)

Type	Speed m/s	Overhead	Pit Depth	Machine Room Height	Car Height
		OH	PH		
Hydraulic C030	0.5	3400	1250	2000	2000
Hydraulic C045	0.75	3400	1250	2000	2000
Traction MR C030	0.5	4400	1200	2400	2000
Traction MR C045	0.75	4400	1200	2400	2000
Traction MRL C030	0.5	3900	1400		2000
Traction MRL C045	0.75	3900	1400		2000



Ceiling	Painted steel sheet
Car Wall	Painted steel sheet
Flooring	Checkered steel sheet
Car Doors	-
Lighting	Semi-indirect

# Cabs and Entrances

Kinetek elevator cabs, entrances and doors are engineered and manufactured to the highest industry standards. We provide complete cabs in a variety of finishes.

Our custom hand and bumper rails (over 20 different styles) provide protection to elevator passengers and your elevator interior, and are compliant with building codes. Traditional door opening styles provided by Kinetek — single slide, center opening and two-speed side or center opening — can be matched with a variety of frames and finishes to complement your project.

## Traditional



HSEQ-609

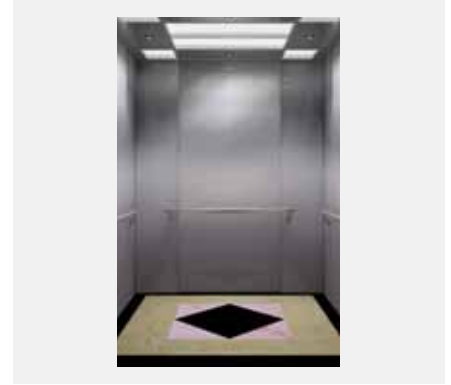

HSEQ-727

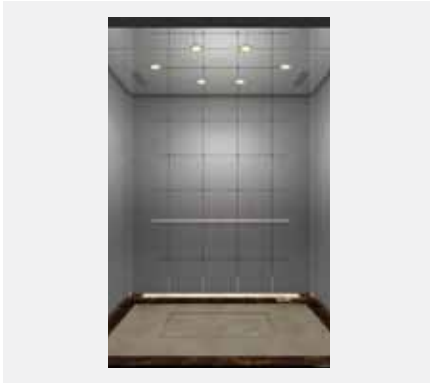

HSEQ-746

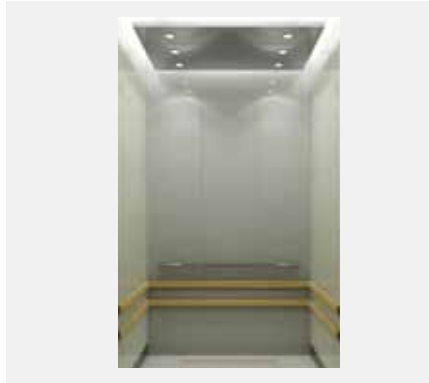

HSEQ-815



HSEQ-830



HSEQ-831



HSEQ-842H

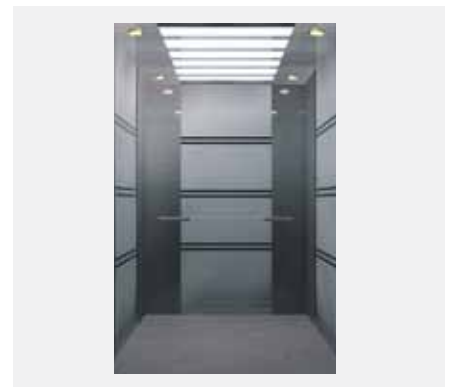

HSEQ-N19

### Traditional

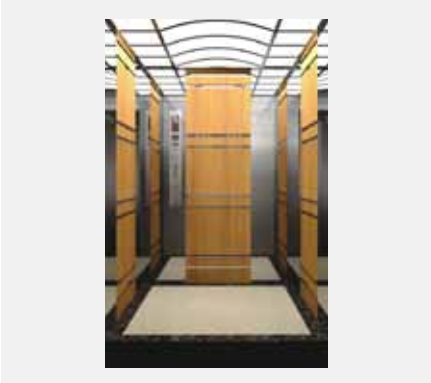

HSEQ-618

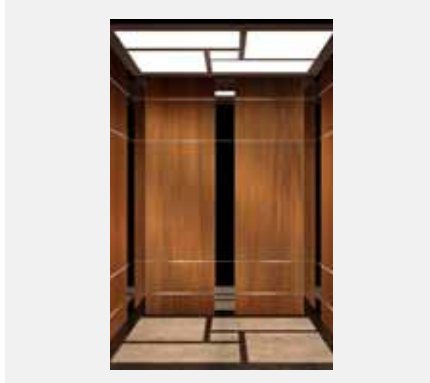

HSEQ-719

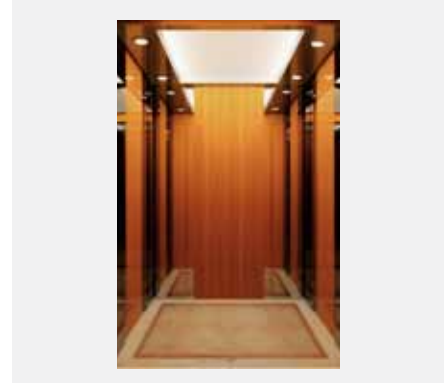

HSEQ-832



HSEQ-742

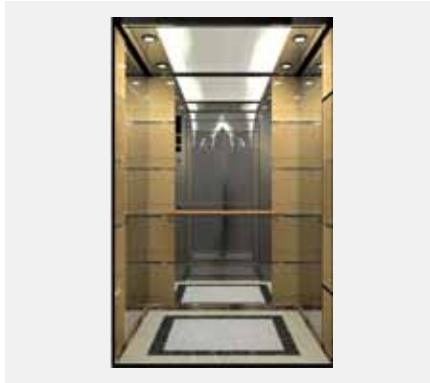

HSEQ-731

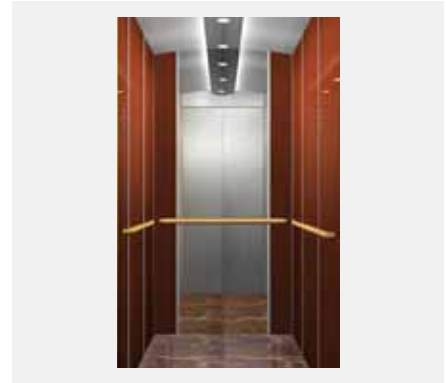

HSEQ-862

### Panoramic



KT-OR001



KT-OR002

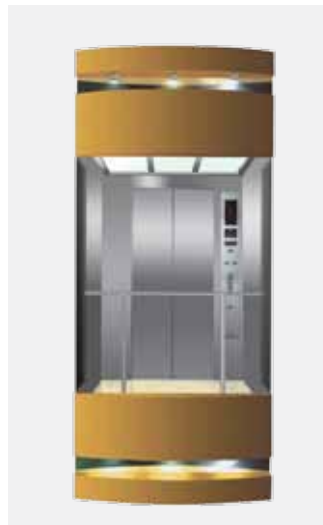

KT-OR003



KT-OR004

## Stainless Steel and Patterned Stainless Steel



Hairline SS



Marine Grade SS



Satin SS



Linished SS



Brushed SS



Chequered



Rhomboids

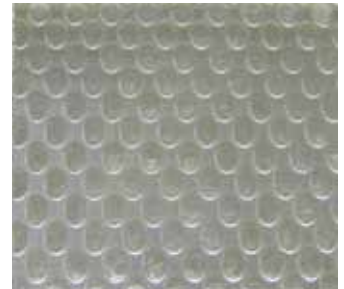

Studded Etched



Mirrored



Multi-Directional Polished



Etched Hairline



Etched Mirror

## Wood Laminates



Cherry



Pear



Beech



Walnut





KT-F001 (PVC)

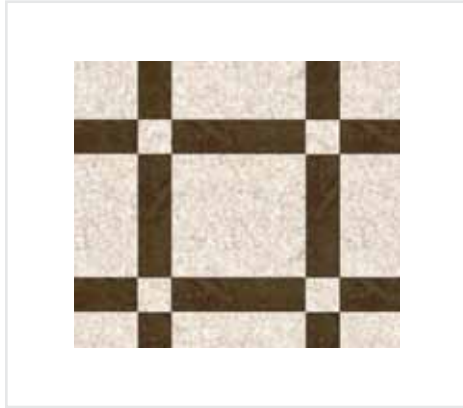

KT-F002 (PVC)



KT-F003 (PVC)

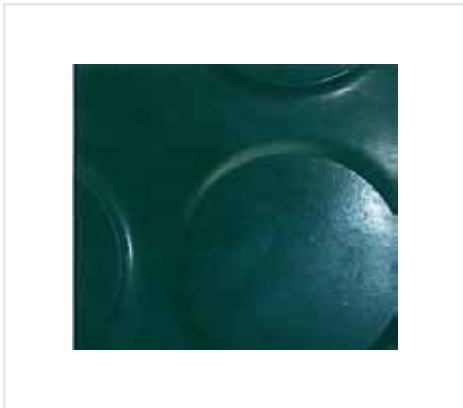

KT-F004 (PVC)

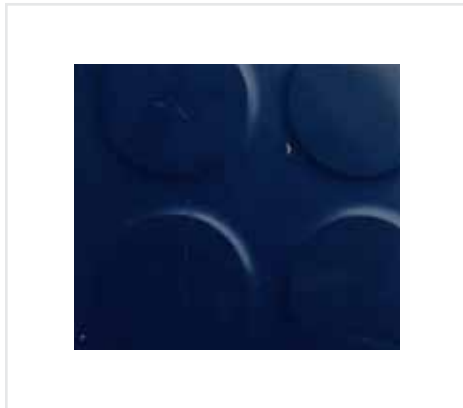

KT-F005 (PVC)

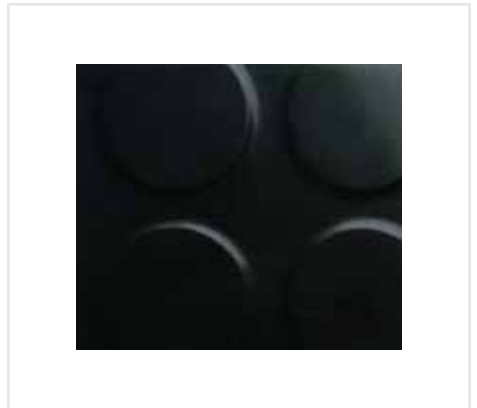

KT-F006 (PVC)

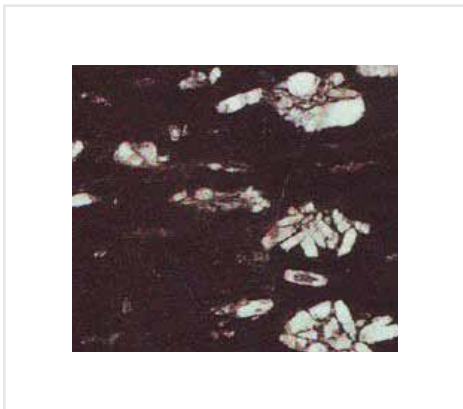

KT-F007 (Marble)

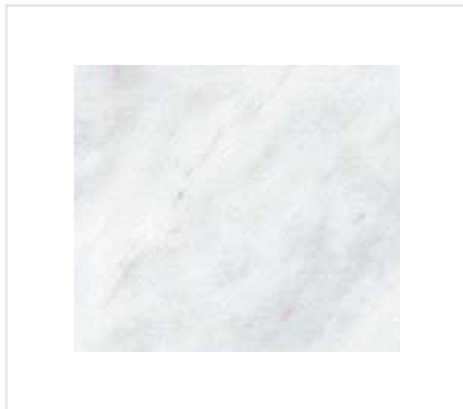

KT-F008 (Marble)

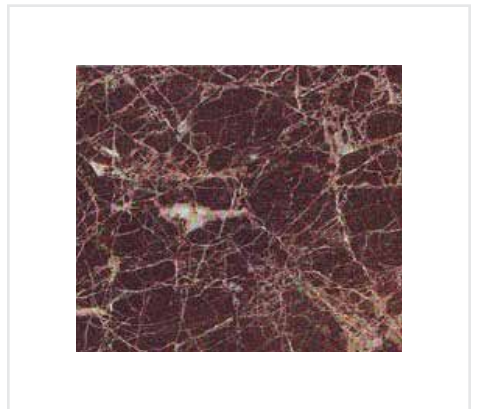

KT-F009 (Marble)

# Lighting

Kinetek provides lighting fixtures that complement car interiors. Over forty standard lighting choices are available.



KT-LT001



KT-LT002



KT-LT003

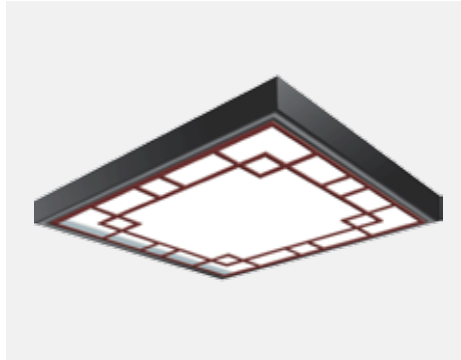

KT-LT004



KT-LT005



KT-LT006



KT-LT007



KT-LT008



KT-OL001



KT-OL002



KT-OL003

Kinetek elevator packages feature beautiful yet rugged car and hall fixtures.





### WJ Series



#### Compact size, powerful acceleration.

Five WJ models are available to accommodate 320 kg to 1000 kg load capacities at speeds from 0.63 to 1.75 m/s.

- New brake design
- 330 mm or 400 mm, 3-5 groove sheave
- 8-10 mm rope, single wrap

### WR Series



#### The perfect MRL solution.

Loading capacity 320 to 1000 kg with 1:1 roping or 450 to 2000 kg with 2:1 roping up to 1.75 m/s.

- Sized for MRL requirements
- Heavy duty construction
- Dual, independent plate brakes

### WTY1



#### Compact package and high performance.

Five WTY1 models are available to accommodate 320 kg to 1600 kg load capacities at speeds from 0.63 to 2.5 m/s.

- 330 mm or 400 mm, 4-8 groove sheave
- 8 or 10 mm rope, single wrap
- Heavy duty construction

### WTY2



#### Power over a wide range with three models available.

Four WTY2 models are available to accommodate 1600 kg to 4000 kg load capacities at speeds from 1.0 to 2.5 m/s.

- Machine and machine room-less
- Harsh environments
- Sheave shaft loads up to 15,000 kg

### SWTY1



#### Compact package and high performance.

SWTY1 machines are perfect for machine room-less or small machine room applications, 320 kg to 800 kg loads at speeds to 2.5 m/s.

- 400 mm sheave
- Heavy duty construction

### Frame 800 Series



#### Power to move the biggest loads.

Frame 800 has the capacity to lift 900 to 2,040 kg at speeds to 6 m/s with 1:1 roping or 1,360 to 3,625 kg at speeds to 3.5 m/s with 2:1 roping.

- Totally enclosed, self-cooling motor — no fan needed
- Supports sheave shaft loads up to 18,140 kg

### SWTY2



#### 1:1 roping for high power requirements.

Robust SWTY2 machines handle loads from 1000 to 2000 kg at speeds to 2.5 m/s.

- 508 or 580 mm sheave

## Safety Components

### Buffers



- Product type: YH/100      YH/175      YH/206
- Maximum nominal speed: 1.0 m/s      1.6 m/s      1.75 m/s
- Minimum impact speed: 1.15 m/s      1.84 m/s      2.01 m/s
- Maximum mass: 900 kg      900 kg      900 kg
- Minimum mass: 3000 kg      3000 kg      3000 kg
- Specification of hydraulic oil: L-HM66

### Governor



- Product type: XS-200
- Scope of application: Bi-directional overspeed governor
- Steel wire rope diameter: 6 mm
- Car rated speed: 1.0 m/s
- Pulling force of safety gear:  $\geq 600$  N

### Safety I



- Product type: AQ10
- Tripping speed: 0.58-2.62 m/s
- Maximum mass: 3000 kg
- Minimum mass: 1200 kg
- Permissible thickness of guide rail blade: 16 mm

### Safety II



- Product type: AQ5Z
- Tripping speed:  $\leq 3.22$  m/s
- Maximum mass: 4000 kg
- Minimum mass: 1200 kg
- Permissible thickness of guide rail blade: 16 mm



# Controllers



Kinetek's iControl, Motion, ZKX 3200, and ZKX 3000 platforms give customers the competitive advantage of controller solutions for low-, mid- and high-rise projects. Incorporating state-of-the-art technology, our industry-leading controllers set the standard for high performance, design and manufacturing, providing customers with products that are more reliable and easier to install, adjust and maintain.

## iControl



### Features and capabilities unmatched in the industry.

iControl is an advanced design controller providing control, monitoring and diagnostic capabilities beyond those of any competitive product.

- Intelligent iBox processor and closed-loop-control, 16K PWM AC or 12-Pulse DC drives.
- Networking technology is built-in with three independent, two-port TCP/IP connections. Operations and access through a LAN switch/router for configuration, monitoring and BMS applications.
- Completely user-configurable using our exclusive iView application, which also provides current status of every important system value, including built-in virtual oscilloscope display.
- iMonitor remote monitoring provides real time display of group and individual elevator status, while iReport lets you gather and display individual car or group statistics over time.
- Reduces machine room cooling requirements, thanks to our PowerBack™ AC Regeneration system.

## Motion 4000 and Motion 4000MRL



### Flexible, high performance traction controls for low- and mid-rise applications.

Flexibility for small machine room or machine room-less installations with application-sized enclosures and components that can be located away from the controller (like Torqmax F5 drive for Motion 4000MRL).

- Configuration and diagnostics are on-board accessible using simple LCD screen and keypad. Inter-board communication is reliable, lightweight, CAN Bus protocol.
- Dual sensor positioning system and machine encoder feedback with independent, three-way data cross-checking eliminates floor zone/leveling magnets and slowdown, emergency and terminal switches.
- Torqmax F5 AC VVVF drive, available in several configurations, supports auto-tuning with AC induction and permanent magnet AC motors, encoder/pole synchronization and serial parameter downloads.
- CAN Bus serial hall call, serial car calls, and serial link from car to controller. Hand-held UI plugs into controller, COP or cartop CAN connection to enable field programming.
- Reduces machine room cooling requirements, thanks to our PowerBack™ AC Regeneration system.

## Motion 2000 Hydraulic Control



### Clean. Simple. Economical. Dependable.

Supporting simplex, duplex or group control, Motion 2000 simplifies interconnectivity and field expansion through CAN Bus technology, phone-style connectors and optimized field connection locations.

- The same straightforward interface, switch programming and LCD display as our previous generation controllers. Hand-held UI plugs into controller, COP or cartop CAN connection to enable field programming.
- Multiple, redundant, self-contained processors provide reliable control and constant safety monitoring. An optional Ethernet port supports real-time connection to iReport, iMonitor and iLobby for real-time monitoring, history, reports and graphic display of activity.



## ZXK 3200C Traction Control



### Simplex/duplex/groups to six cars.

Service to 64 floors, single or double openings. AC VVVF control of AC induction or permanent magnet machines. The ZXK 3200C uses modular architecture centered around the CPU main control board and the car control board. The control board provides simple CAN Bus connectivity for just the number of hall call control boards required. The car control board uses CAN connected car instruction boards (one for every 6 landings served) for easy interface to small or large car operating panels. CAN Bus car and hall call communication allow less bulk and lower cost in traveler and hoistway cabling.

- Remote monitoring available
- Load weighing
- EN81 compliant
- Battery backup via UPS system
- Dispatching and back up dispatching with no separate enclosures required
- Door pre-opening
- Serial hall and car call

## ZXK 3000B Traction Control



### Simplex/duplex/groups to six cars.

ZXK 3000B VVVF and VVVF MRL uses a building block approach resulting in a small number of circuit boards with logically grouped functionality, linked by a high speed CAN bus. The main controller handles hoistway and machine room equipment. The car control board handles all car related equipment.

- CAN Bus communication
- Factory matched motors/machines
- EN81 compliant main board with CE certificate
- Door pre-opening (optional)
- Double door machine control (optional)
- Automatic leveling (optional)
- Electric brake release (optional)

Controller	Contract Speed (meters per second)	Floors/Openings	Group Size
iControl AC & DC	10 m/s	150 / 300	to 15 cars
Motion 4000 AC	6 m/s	32 / 64	to 8 cars
Motion 4000 AC MRL	4 m/s	32 / 64	to 8 cars
ZXK 3200	4 m/s	64 / 128	to 6 cars
ZXK 3000B	4 m/s	64 / 64	Simplex/Duplex
Motion 2000 Hydraulic	200 fpm — 1.0 m/s	32 / 64	to 8 cars
Motion 3000ES Escalator	Limited to 100 fpm — 0.5 m/s in most areas	N/A	N/A

## Motion 3000ES Escalator Control

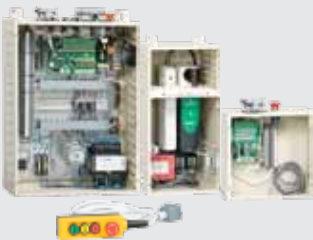

### Variable speed or direct line control.

Field programmable escalator control available with VVVF Variable Speed or Wye/Delta Direct Line Control. Motion 3000ES provides hardware flexibility, allowing enclosure size and motor drive, control keypad, and processor board locations (in cabinet or remote) to vary depending on the needs of the installation. Motion 3000ES is fully ASME A17.1, CSA B44.04, BS EN 115, and AS 1735.5 compliant, with independent, redundant safety string inputs, signal path and processing to ensure safe operation. Motion 3000ES controls feature:

- Prominent, externally accessible machine controls
- High speed CAN serial bus communication
- High visibility LED message and parameter displays
- Multiple remote display support
- Direct parameter entry (no external devices required)
- Cabinet or remote mount inspection control sockets

## iMonitor

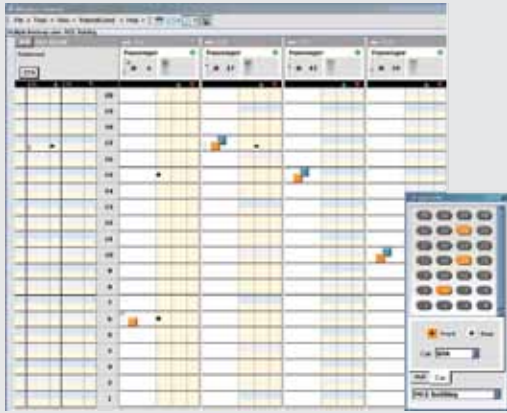

## MRL Remote Rescue™



### Elevator group monitoring application.

iMonitor provides real-time viewing and access — for elevators just across the hall, in multiple buildings across a campus, even multiple sites across the country. iMonitor's graphical presentation and real-time connectivity provide up-to-the-minute information and allow you to take control if needed.

iMonitor provides general views of multiple elevator groups, hoistway views of multiple cars within a group or detailed views of selected cars. Create "connection sets" to display — each connection set consists of up to fifty connections to elevator group dispatchers, each of which may be at a different physical site.

iMonitor also allows you to configure hall and car call security, enable or disable special group modes of operation, recall a car to a floor you specify, control its door operation at that floor and enable or disable individual car operating modes.

### High level multi-group view.

Use iMonitor's high-level views to maintain a broad perspective on several groups simultaneously.

### Detailed single-group view.

Narrow your attention to cars in a particular elevator group with a click of the mouse.

### Maximum safety through visibility.

Kinetek's innovative MRL Remote Rescue™ incorporates video imaging and battery power to allow a technician to safely move the car to a landing if commercial power is lost. A car-mounted camera sends video to an LCD screen in the controller. Using a button to control battery-provided brake lift power, and watching the LCD, the technician moves the car to a landing, aligning a marker on the LCD with a graphic in the hoistway to stop the car in the landing zone.

Kinetek's Destination Based Dispatching is an innovative dispatching system that enhances building traffic flow by intelligently matching passengers to elevator cars and achieving optimal efficiency.

The technology behind this system uses complex algorithms, but the passenger experience is quite simple: After selecting the desired floor on a touchscreen, passengers are directed to the elevator that will take them to their destination. It's just that simple.

Everyone familiar with traditional dispatching — where passengers wait impatiently for the first elevator to arrive and then gather at the elevator as the door opens — knows the pressure of catching the next elevator. With Destination Based Dispatching, passengers can relax because they know in advance which elevator is coming to meet them.

Destination Based Dispatching allows the most efficient passenger elevator assignment for a given number of floors, passengers per elevator, and minimum number of stops per elevator. It provides an alternative to the typical busy scenario where a crowd of passengers enters an elevator, each needing to select a floor when they board and then enduring the wait as the elevator stops at several floors — sometimes depositing just one passenger per floor. And this process is duplicated for every elevator in the group. Effective Destination Based Dispatching eliminates this inefficiency by assigning groups of passengers with the same destination to the same elevator, resulting in far fewer stops and improving transit time.

Destination Based Dispatching also provides an ideal solution to minimize expense and maximize efficiency during up-peak traffic times. It's called Lobby Boost, and it uses Destination Based Dispatching on the lobby floors but standard fixtures and dispatching on other floors.

## Touchscreen Technology



Passenger selects desired floor, then is directed to specific elevator.

## Traffic Handling Benefits



**Traditional dispatching** results in a high mix of destinations per car, requiring more stops and more time.



**Destination based dispatching** results in a low mix of destinations per car, requiring fewer stops and less time.



## 35° Escalator Layout

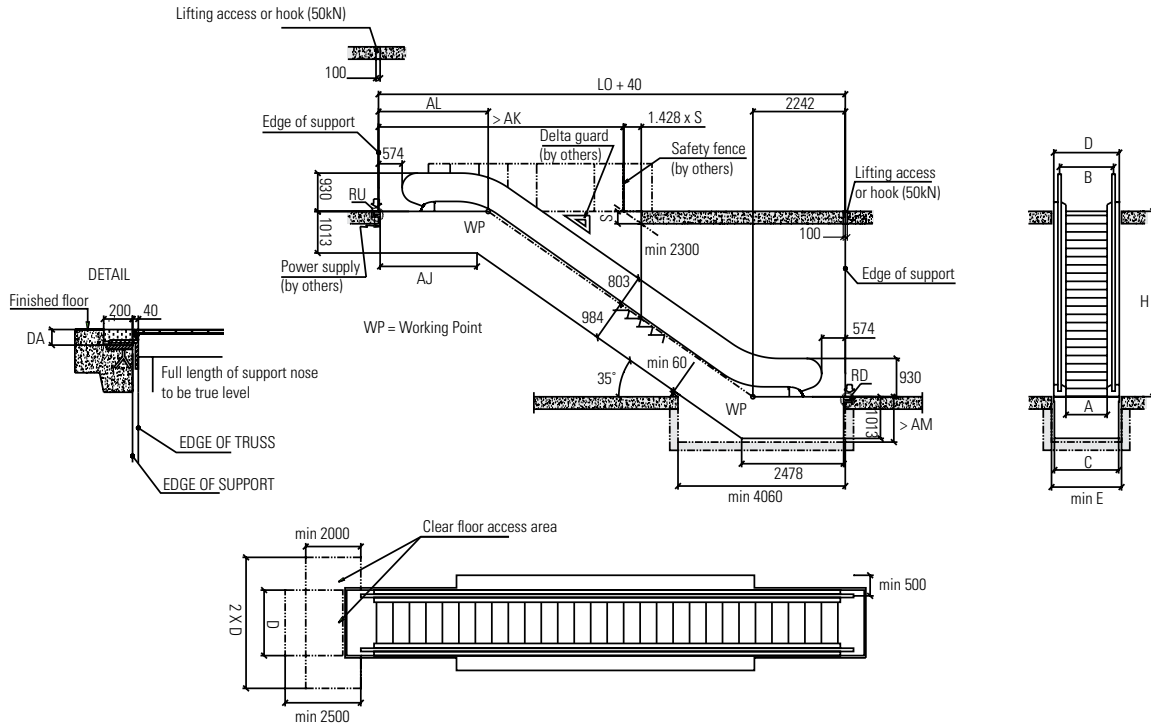

## 35° ESCALATOR SPECIFICATIONS

A	B	C	D	E	AJ	AK	AL	L	AM	DA
600	837	1100	1130	1240	2844	6450	3163	1.428H + 5405	In- / Outdoor Model A 1103	No rubber shock absorber 108
800	1031	1300	1330	1440	2344	5950	2663	1.428H + 4905	Outdoor Model B with oil separator 1353	Rubber shock absorber 128
1000	1231	1500	1530	1640						

### KM 160

- Vertical worm gear traction machine, 380 VAC, 50/60 Hz
- Brake voltage - 220 VAC

### KM H1

- Horizontal, helical gear traction machine, 380 VAC, 50/60 Hz
- Brake voltage - 220 VAC
- Reduces energy consumption by 30% over traditional, vertical worm gear machines

RISE / POWER / SPEED				
Type	Step Width mm	Max Height m	Power kW	Speed m/s
KM H1	1000	5.1	7.5	0.5
		6.0	9.5	0.5
	800	6.0	7.5	0.5
		600	6.0	7.5
KM 160	1000	4.7	7.5	0.5
		6.0	9.0	0.5
	800	6.0	7.5	0.5
		600	6.0	7.5

REACTIONS kN		
Step Width mm	Support Point	2 Supports
1000	RU	5.11L + 13
	RD	5.11L + 5
800	RU	4.41L + 15
	RD	4.41L + 9
600	RU	3.76L + 18
	RD	3.76L + 12





Single

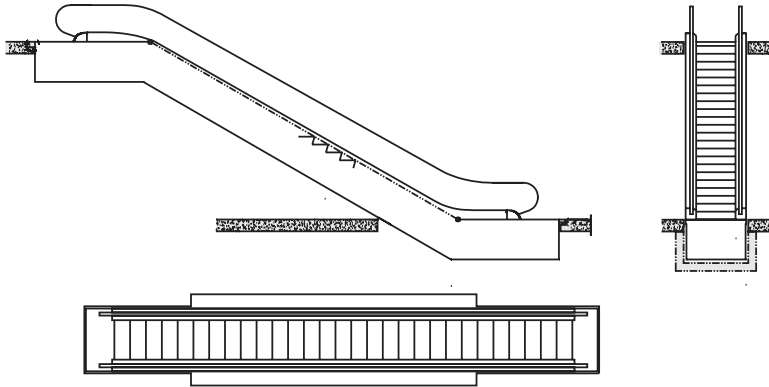

Side by Side

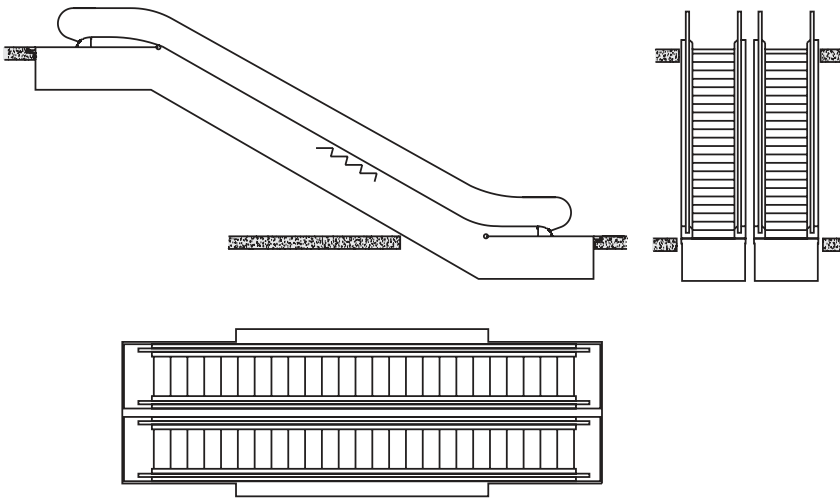

Side by Side Opposing

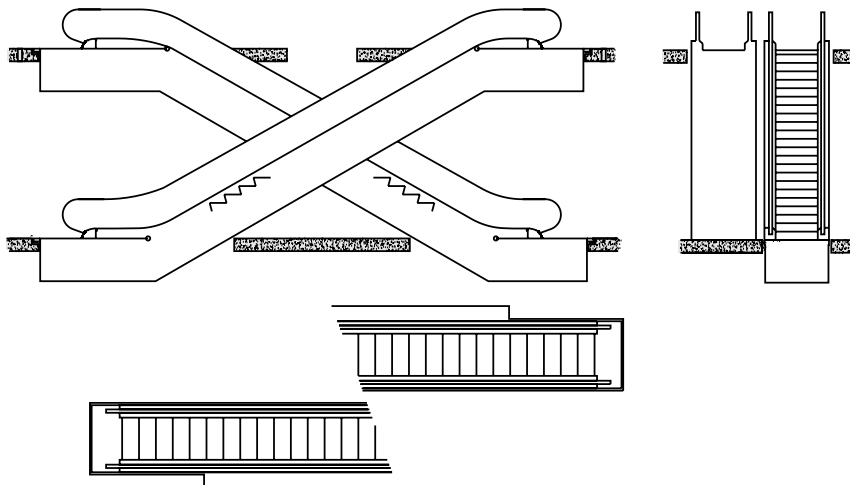

## Contacts

### **Australia**

Hani Hallak  
Phone: +1 916 463 9329  
Email: hani.hallak@mceinc.com  
Fax: +1 916 858 4329

### **Europe**

Julian Barnett  
Phone: +44 (0) 1204 695 797  
Email: julian.barnett@kinetekinc.com  
Fax: +44 (0) 1204 690 098

### **India**

Nashvinder Singh  
Phone: +91 93562 94375  
Email: nashvinder.singh@kinetekinc.com

### **Latin America**

Jairo Guerrero  
Phone: +1 916 463 9238  
Email: jairo.guerrero@mceinc.com  
Fax: +1 916 858 4238

Carlos Gonzalez  
Phone: +1 916 463 9313  
Email: carlos.gonzalez@mceinc.com  
Fax: +1 916 858 4313

### **Middle East**

Mohamed Ezeddine  
Phone: + 971 50 3500856  
Email: mohamed.ezeddine@mceinc.com  
Fax: +1 916 463 9201

### **Turkey**

Ismail Kosovali  
Phone: +90 212 486 01 10  
Email: ismail.kosovali@kinetekinc.com  
www.kinetekinc.com



**KINETEK®**

*Technology in Motion*